

Clamping Set

Use in conjunction with the cable interception system or the cable support for the centric insertion and fixing of the cable. The clamping set has to be selected according to the outer diameter of the cable and must be ordered separately.

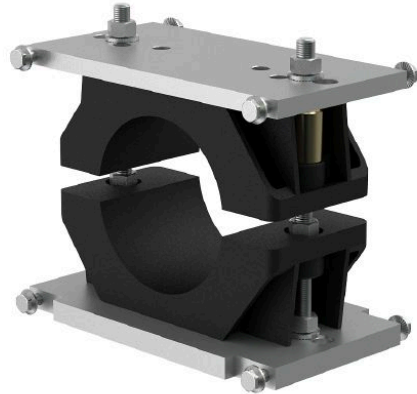

Picture may vary.

Technical Data

Article no.	562 438 005
Type	Clamping Set
For cable diameter	(mm) 160 - 200